

REGISTRATION NUMBER

DVH 0490

DATE OF REGISTRATION/PUBLICATION

9 28 2011  
Month Day Year

DO NOT WRITE ABOVE THIS LINE. IF YOU NEED MORE SPACE, USE A SEPARATE CONTINUATION SHEET. (Form D-VH/CON)

**1**

TITLE

Please give the make and model of the vessel that embodies the design.

Sea Fox Bay Fox 200XT

**2**

DESIGN

(a) What is the type or style of the design for which registration is sought?  
(b) Provide a brief general statement setting forth the salient features of the design.  
(c) If this design is derived from an earlier design, describe how that design has been revised, adapted, or rearranged.

What is the type or style of the design for which registration is sought?

Center-console bay boat

Provide a brief general statement setting forth the salient features of the design.

Hull form and shape;

Deck configuration and layout; integrated planing pods in transom; reverse transom configuration;

progressive downward strake design on hull

Check here if this is a single design.  
 Check here if registering more than one design. Use Form D-VH/CON for additional designs.

**3**

DESIGNER(S)

Provide the name and address of the designer(s). The name of the employer may be given instead of the designer(s) if, (1) the design was made within the regular scope of employment of the designer(s) and (2) the individual authorship of the design is difficult or impossible to ascribe.

Please check here if those conditions are satisfied and you are providing the employer's name.

Name: Sea Fox Boat Company, Inc.

Name: \_\_\_\_\_

Address: 2550 Hwy. 52

Address: \_\_\_\_\_

Moncks Corner, SC 29461

**4**

OWNER, IF NOT DESIGNER(S)

If the owner is different from the designer(s) or employer named above, provide the name and address of the owner:

Name: \_\_\_\_\_

Address: \_\_\_\_\_

**5**

PRIORITY CLAIM

(a)

Was an application for registration of this design identified in an application filed in a foreign country that extends to designs of owners who are citizens of the United States, or to persons filing applications in the United States, similar protection to that afforded in 17 USC chapter 13?

Yes  No

(b)

If yes, identify the country and date of application:

Country: \_\_\_\_\_

Date of application: \_\_\_\_\_

Serial No: \_\_\_\_\_

**6**

DATE MADE PUBLIC

Was this design made public before the date of application?  Yes  No

If yes, on what date? September 1 2010  
Month Day Year

DO NOT WRITE HERE OFFICE USE ONLY

APPLICATION RECEIVED

9/28/2011

DESIGN COPIES RECEIVED

9/28/2011

FUNDS RECEIVED

9/28/2011

EXAMINED BY JJA

FORM D-VH

CHECKED BY Don H

CORRESPONDENCE

Yes

FOR  
COPYRIGHT  
OFFICE  
USE  
ONLY

DO NOT WRITE ABOVE THIS LINE. IF YOU NEED MORE SPACE, USE A SEPARATE CONTINUATION SHEET. (Form D-VH/CON)

7

Please provide the name and address of the person to whom correspondence regarding this application may be directed:

CONTACT  
PERSON

Name: David Cox, Esq.

Address: 5 Exchange Street

Charleston, SC 29401

Email address dcox@wcsr.com

FAX number 843-723-7398

Daytime phone: (843) 720-4665

8

Give the name and account number if the registration fee is to be charged to a deposit account established in the Copyright Office:

DEPOSIT  
ACCOUNT

Name of Account: \_\_\_\_\_

Account number: \_\_\_\_\_

9

**DECLARATION:** The undersigned, as the applicant or the applicant's duly appointed agent or representative, being hereby warned that willful false statements are punishable by fine or imprisonment, or both, under 17 USC §1001, and that such willful false statements may jeopardize the validity of this application or any resulting registration, hereby declares to the best of his or her knowledge and belief:

- (1) that the design has been fixed in a useful article;
- (2) that the design is original and was created by the designer(s), or employer if applicable, named in the application;
- (3) that those aspects of the design for which registration is sought are not protected by a design patent;
- (4) that the design has not previously been registered on behalf of the applicant or applicant's predecessor in title; and
- (5) that the applicant is the person entitled to protection and to registration under chapter 13 of title 17, *United States Code*.

Complete if applicable:

The design has been made public with a design notice as prescribed by 17 USC §1306.

Following is the exact form of the design notice:

Where on the useful article is the design notice located?

If the undersigned is not the applicant, he or she is properly authorized to execute this application on behalf of the applicant.

Ryan Balderson

Print or type name

843-761-6090

Telephone number

Fax number

Date 9/20/2011

VP of Product Development

Position or title

rbalderson@seafoxyboats.com

Email address

Copyright Office fees are subject to change. For current fees, check the Copyright Office website at [www.copyright.gov](http://www.copyright.gov), write the Copyright Office, or call (202) 707-3000.

Certificate  
will be  
mailed in  
window  
envelope  
to this  
address:

Name ▼

David Cox, Esq.

Number/Street/Apt ▼

5 Exchange Street

City/State/Zip ▼

Charleston, SC 29401

**YOU MUST:**

- Complete all necessary spaces
- Sign your application in space 9

**SEND ALL 3 ELEMENTS  
IN THE SAME PACKAGE:**

1. Application form
2. Nonrefundable filing fee in check or money order payable to Register of Copyrights
3. Design material

**MAIL TO:**

Dept. D-VH  
Vessel Hull Registration  
PO Box 71380  
Washington, DC 20024-1380

17 USC §1327. Penalty for false representation. "Whoever knowingly makes a false representation materially affecting the rights obtainable under this chapter for the purpose of obtaining registration of a design under this chapter shall pay a penalty of not less than \$500 and not more than \$1,000, and any rights or privileges that individual may have in the design under this chapter shall be forfeited."

SEAFOX 200xt Bay Fish

Library of Congress  
Received

SEP 28 2011

U.S. Copyright Office

DVH 0490

Fig 1

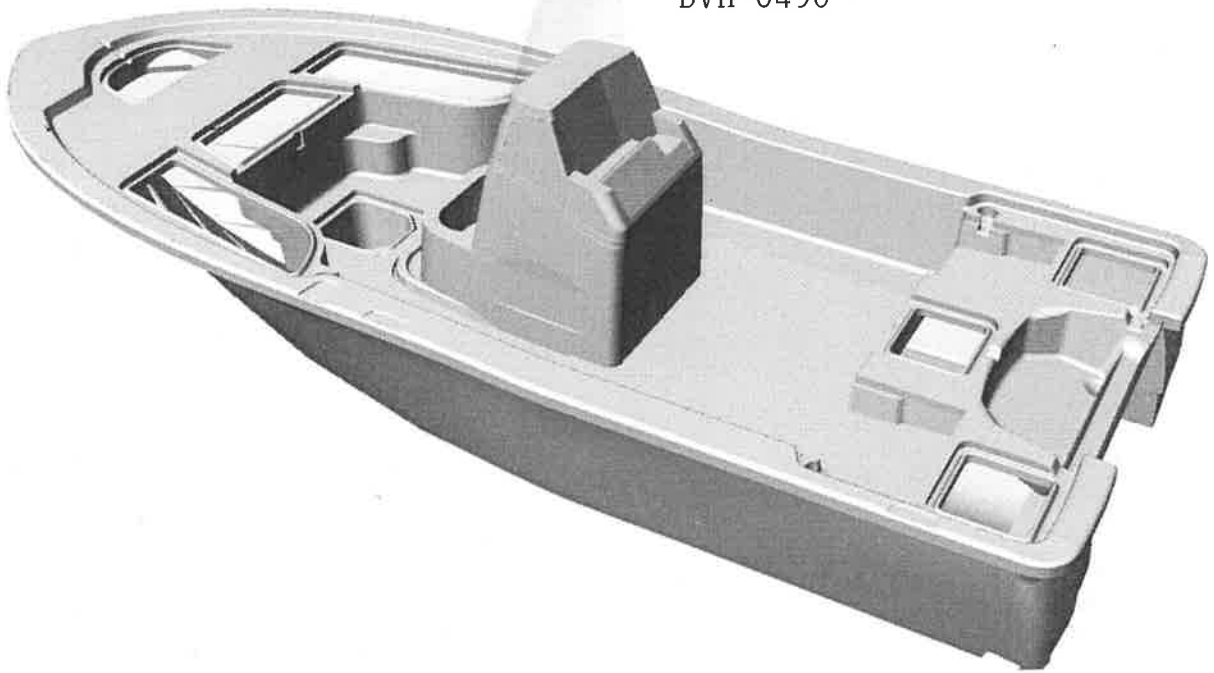

SEAFOX 200xt Bay Fish

Fig 2

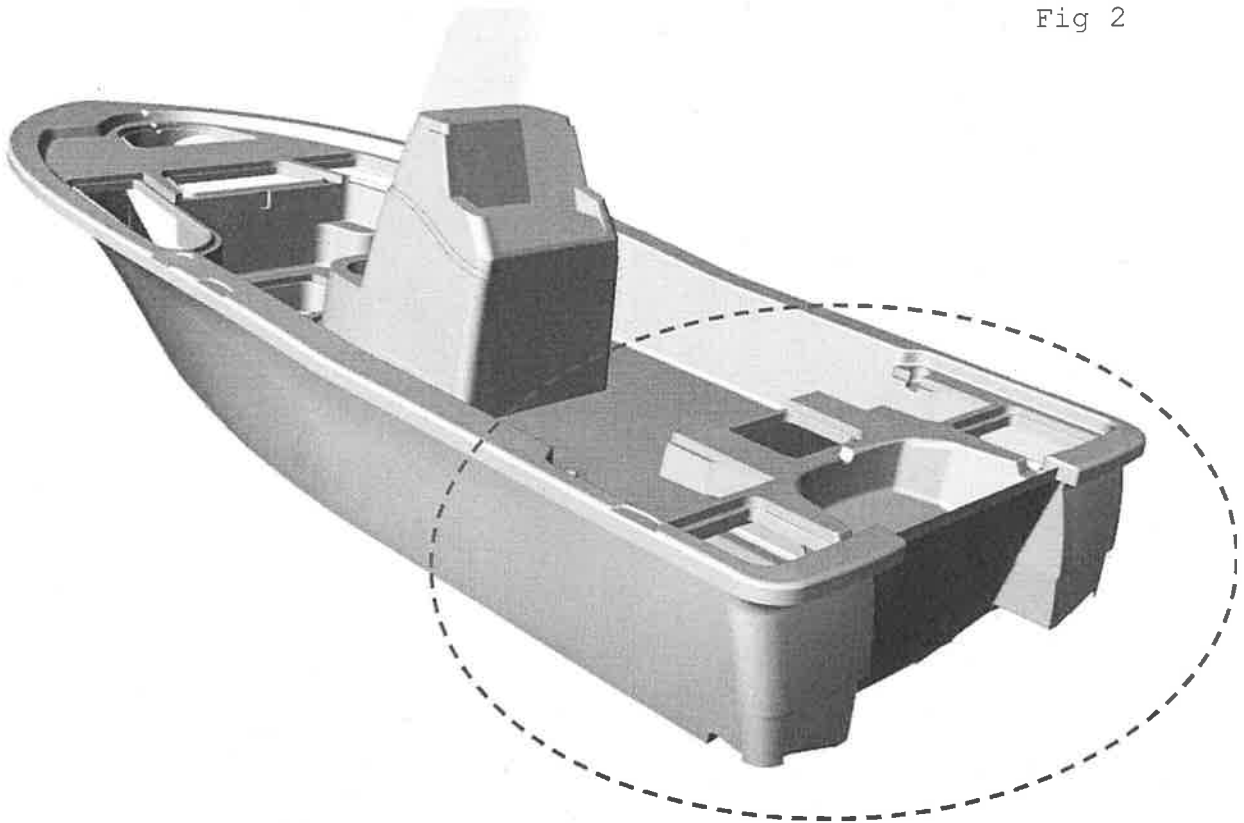

SEP 28 2011

U.S. Copyright Office

DVH 0490

SEAFOX 200xt Bay Fish

Fig 3

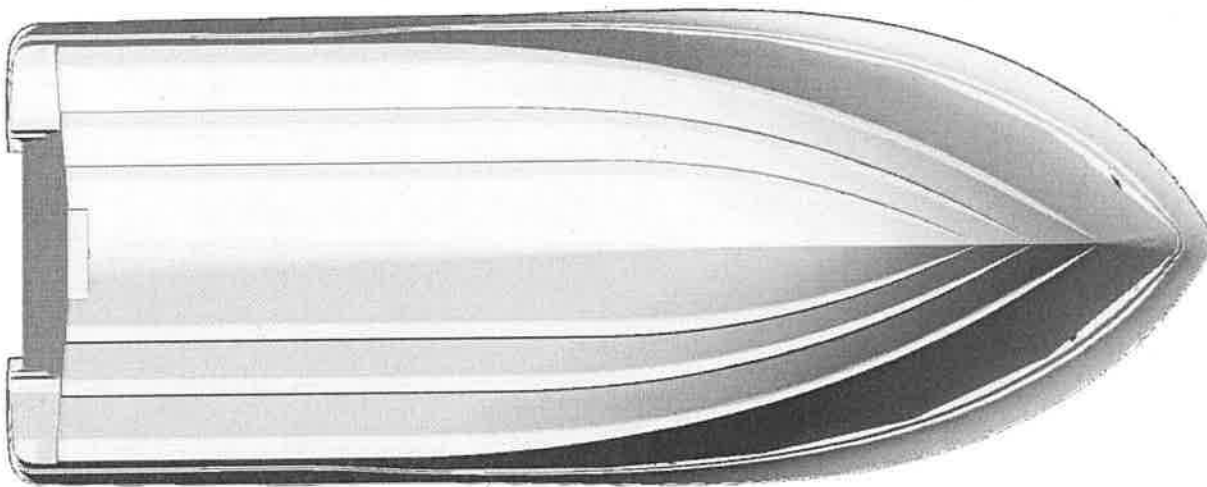

SEAFOX 200xt Bay Fish

Fig 4

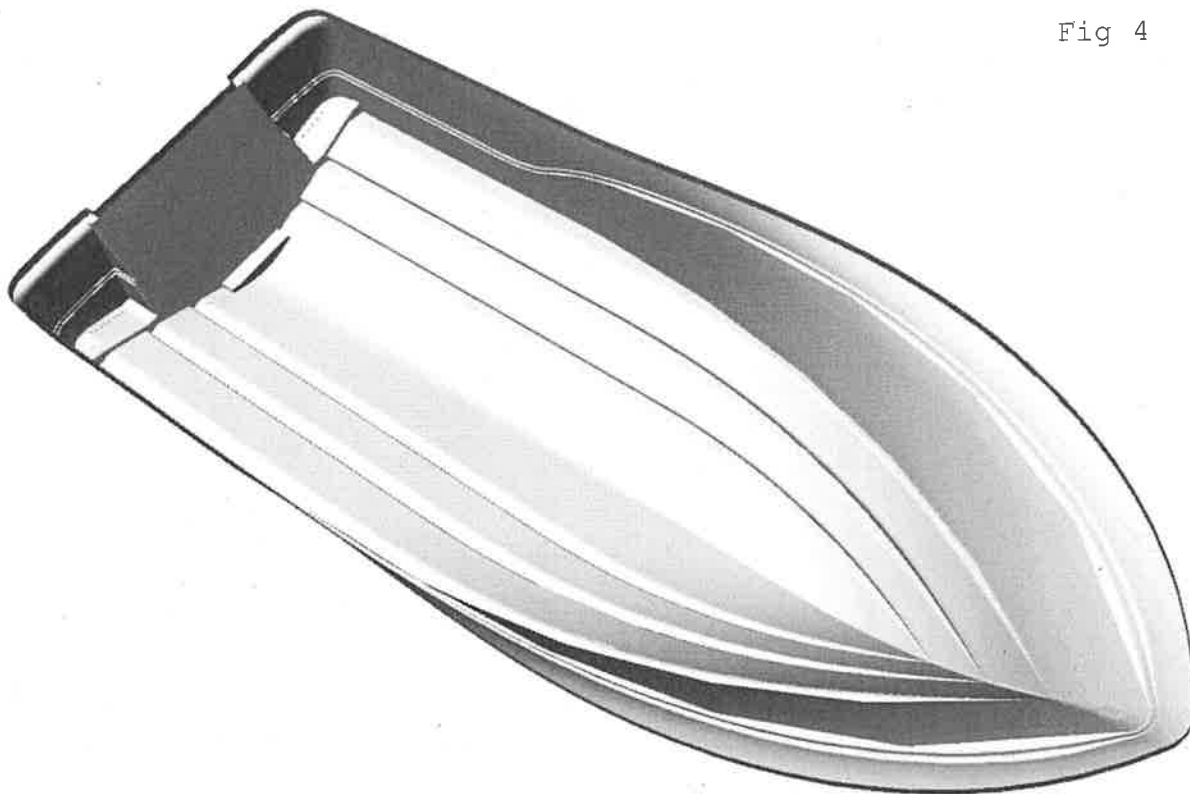

SEAFOX 200xt Bay Fish

Library of Congress  
Received

SEP 28 2011

U.S. Copyright Office

DVH 0490

Fig 5

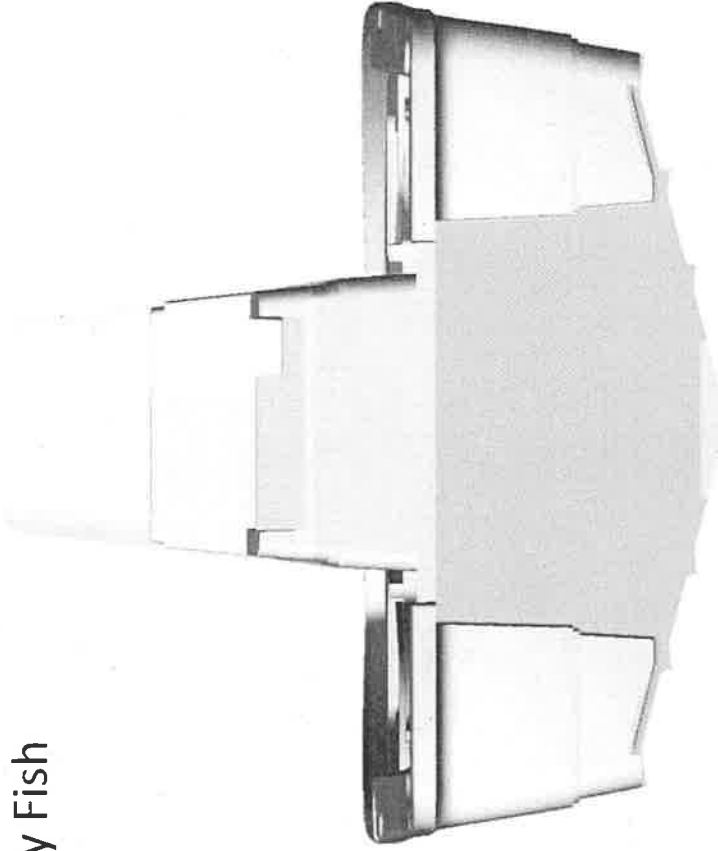
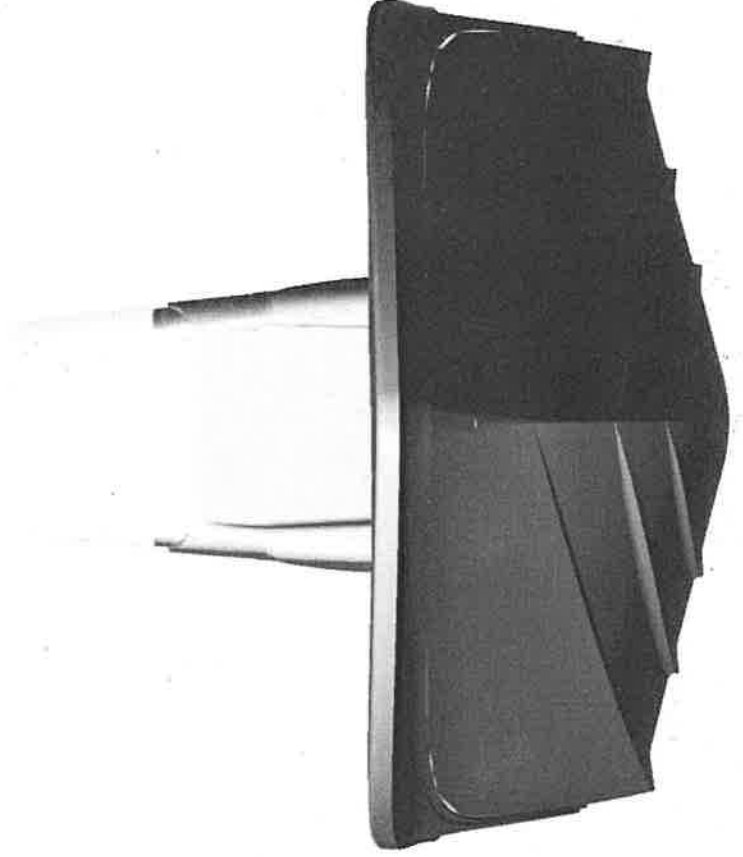

Fig 6



SEAFOX 200xt Bay Fish

Library of Congress  
Received

SEP 28 2011

U.S. Copyright Office

DVH 0490

Fig 7

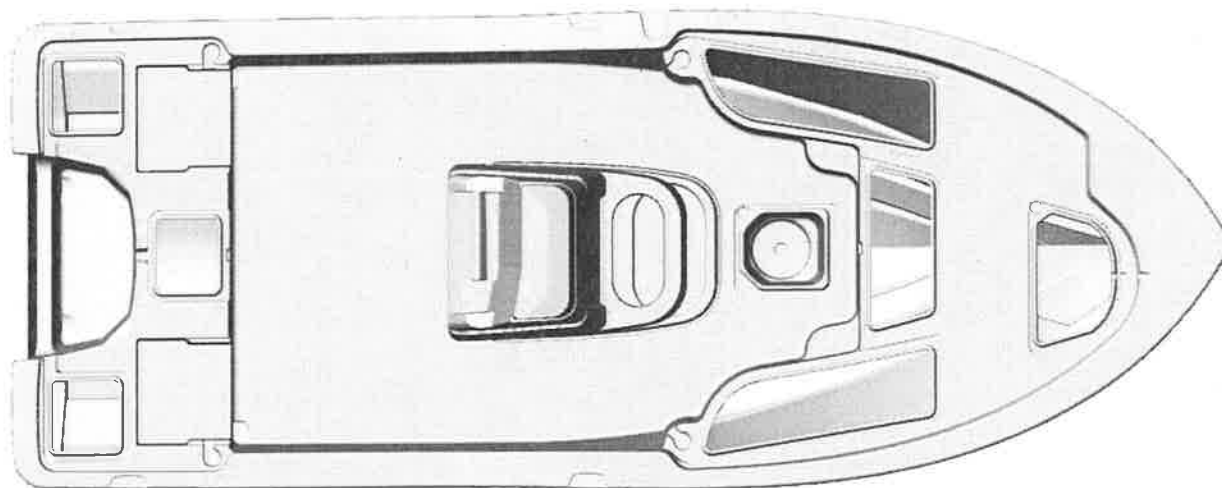

SEAFOX 200xt Bay Fish

Fig 8

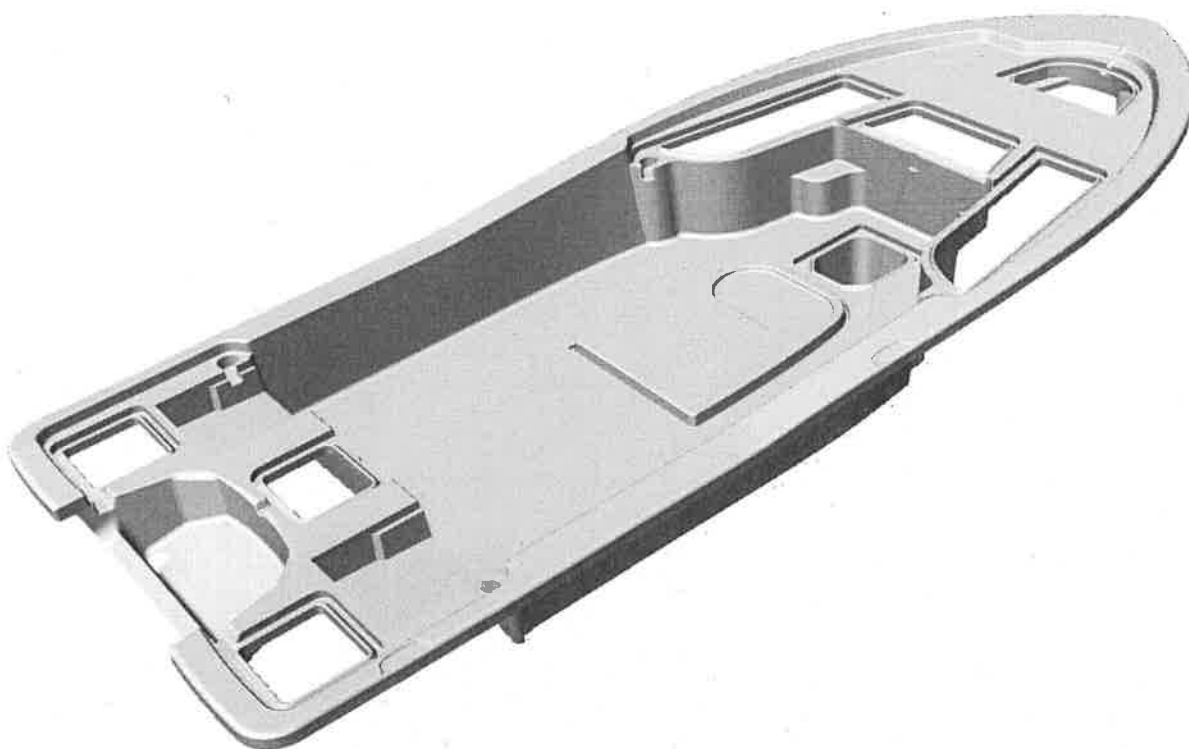

SEAFox 200xt Bay Fish

Library of Congress  
Received

SEP 28 2011

U.S. Copyright Office

DVH 0490

Fig 9

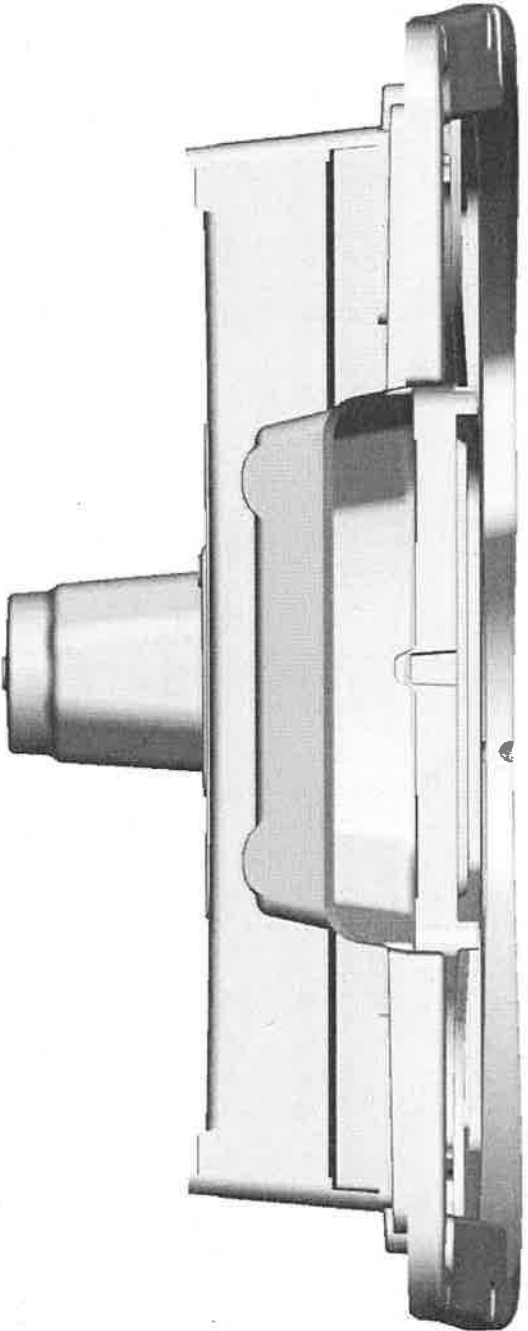
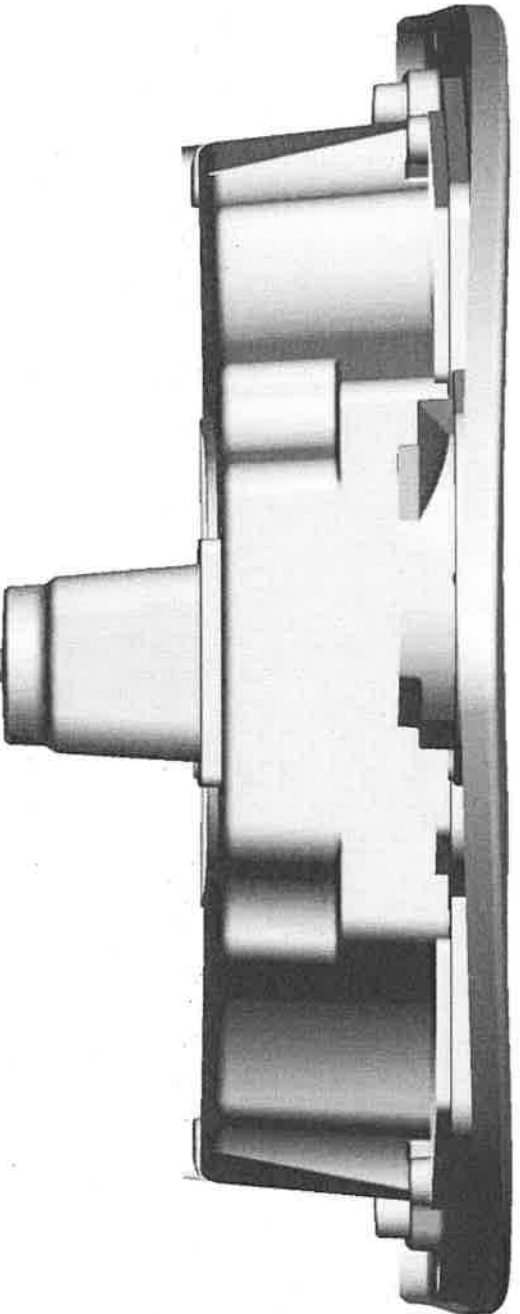

Fig 10



SEAFox 200xt Bay Fish

Library of Congress  
Received

SEP 20 2011

U.S. Copyright Office

DMH 0490

Fig 11



Fig 12





SEAFox 200xt Bay Fish

Library of Congress  
Received  
SEP 28 2011

U.S. Copyright Office  
DVH 0490

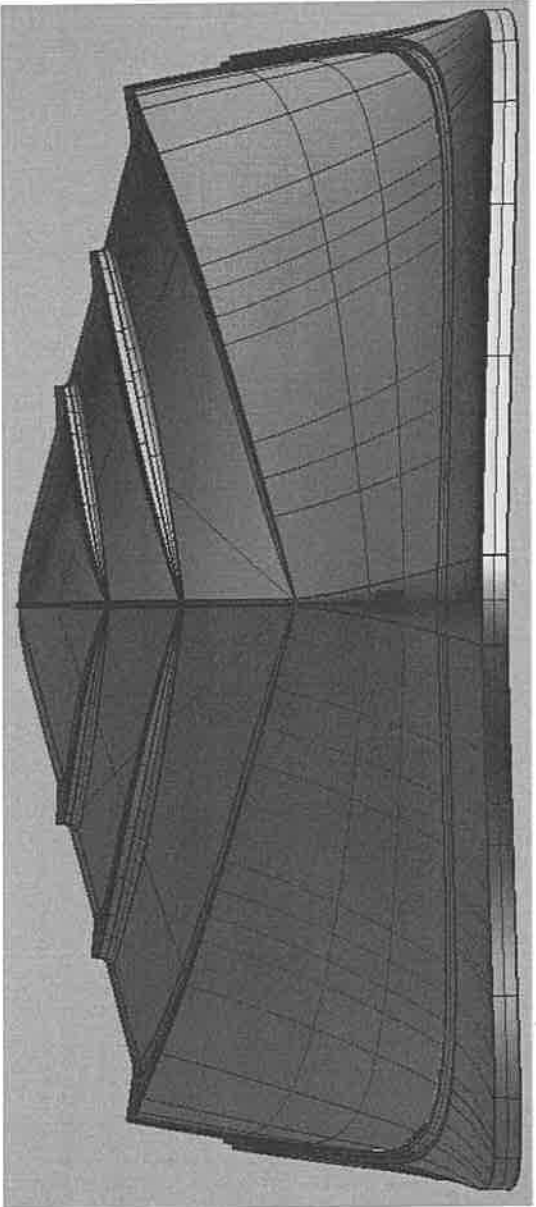

Fig 13

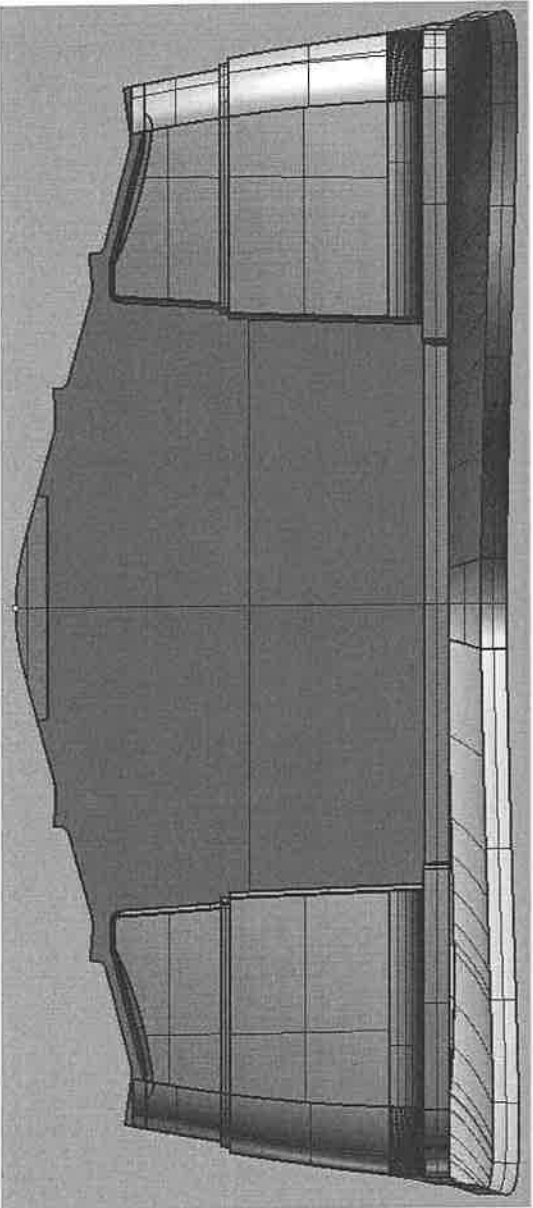

Fig 14

SEAFOX 200xt Bay Fish

Library of Congress  
Received

SEP 28 2011

U.S. Copyright Office

DVH 0490

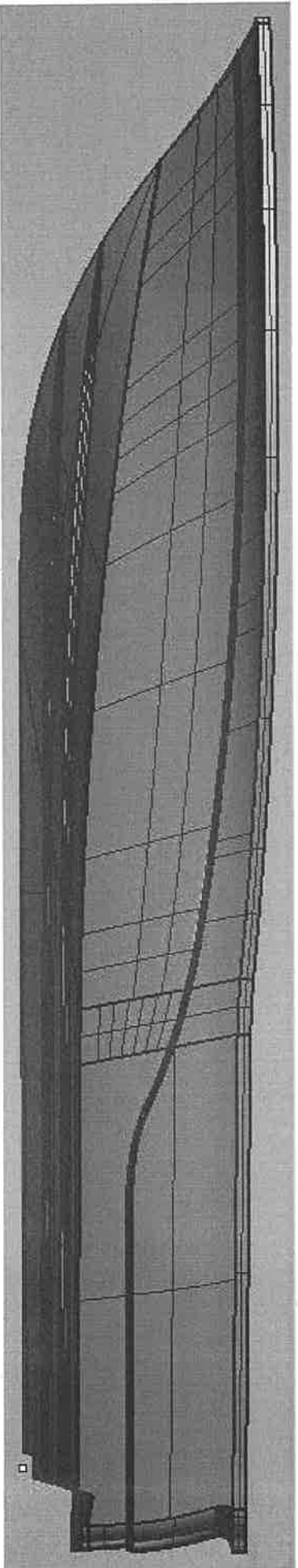

Fig 15

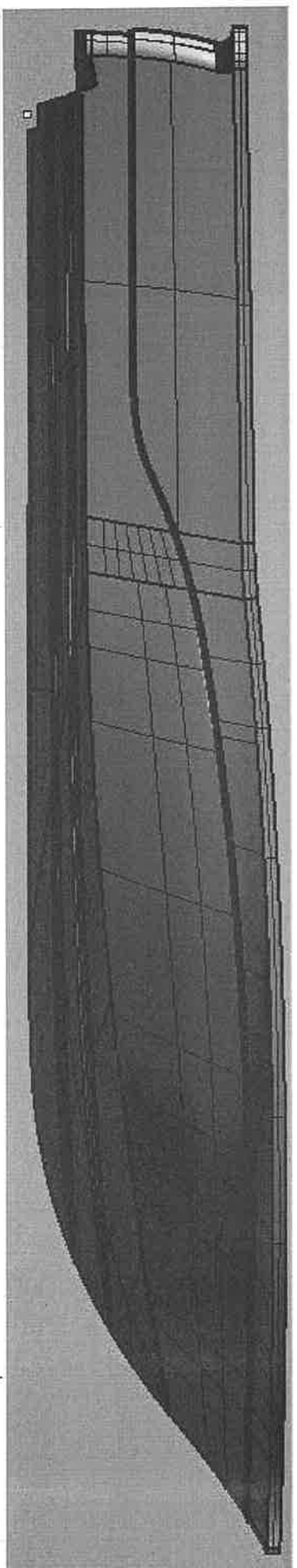

Fig 16

SEAFOX 200xt Bay Fish

Library of Congress  
Received

SEP 28 2011

U.S. Copyright Office

DVH 0490

Fig 17

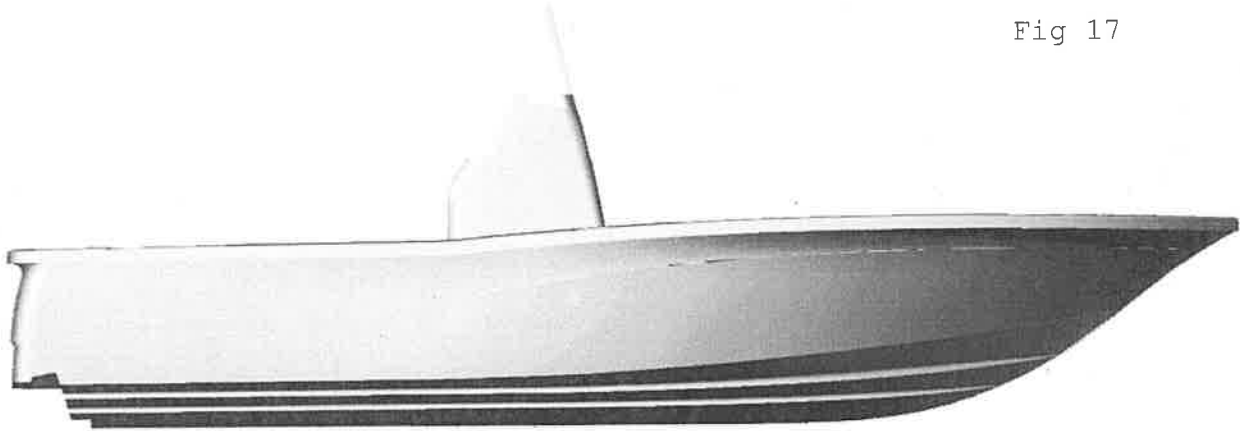

SEAFOX 200xt Bay Fish

Fig 18

